

Maßblätter TGW 25

Entfeuchtungsgeräte

Made in Germany

in Truhenbauweise mit Wärmerückgewinnung

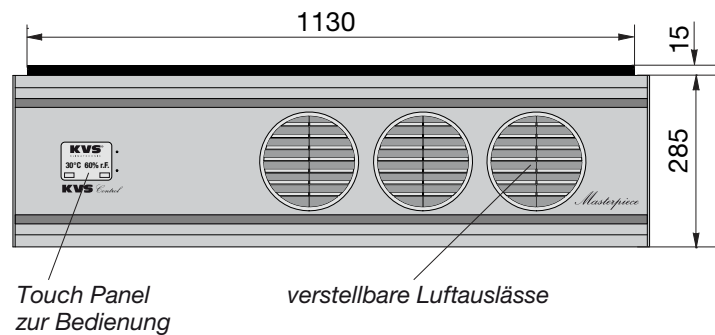
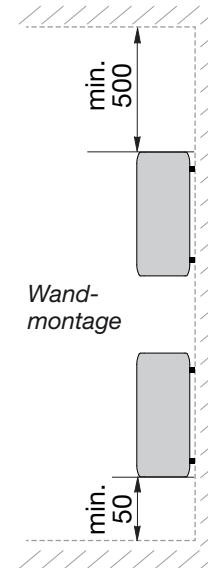
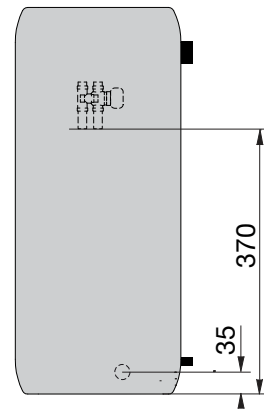
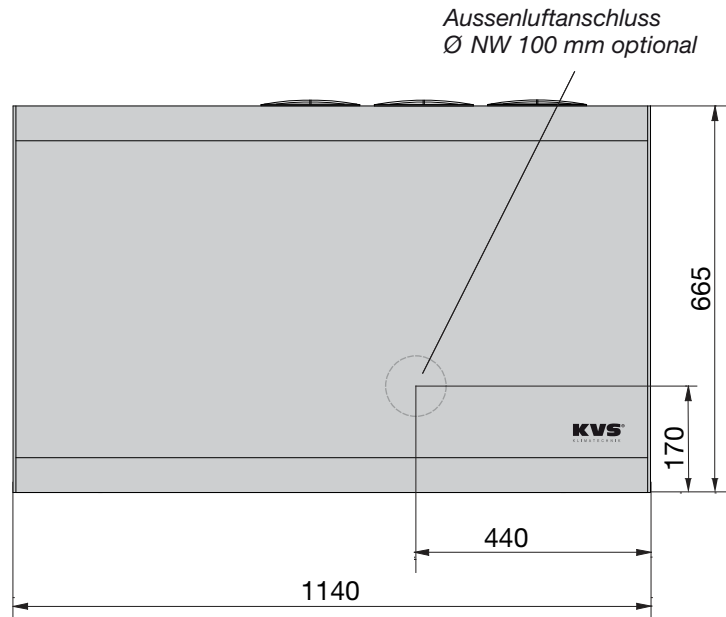

Tauwasser-Ablaufwinkel
Schlauchanschluss Ø 12 mm (1/2")

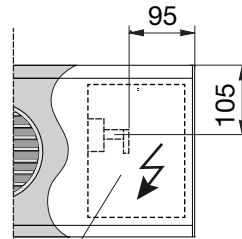

Elektrokabel-Bedarf
im Gerät ca. 1,5 m

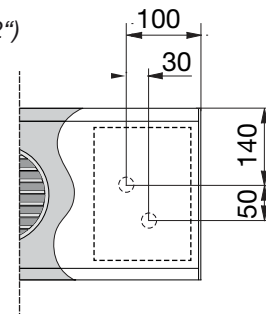

PWW-Heizungsanschluss
1/2" Aussengewinde